

4000-60" SLITTER

GARY®

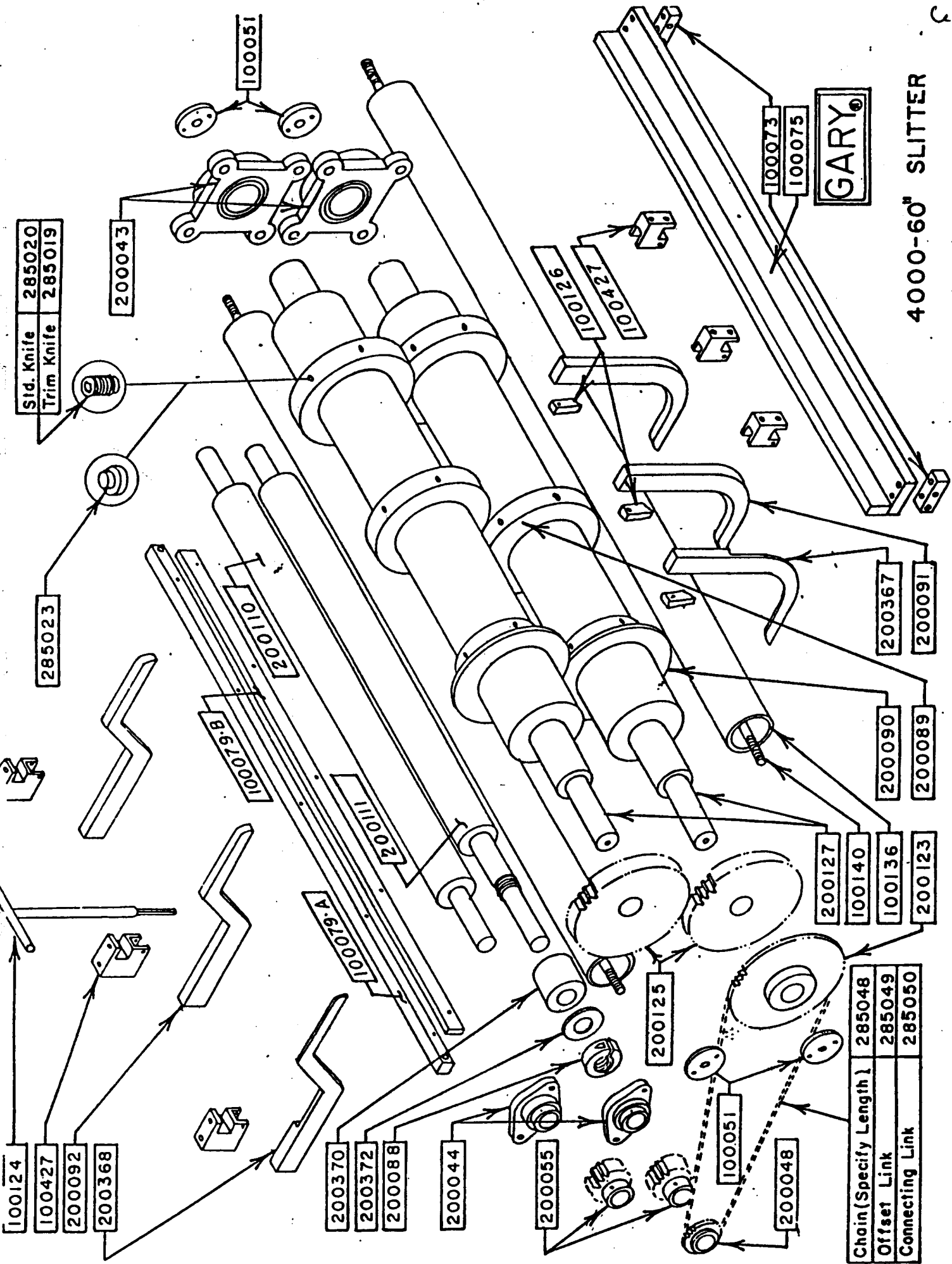

Std. Knife	285020
Trim Knife	285019

200043

100051

100073

100075

100102

100101

285023

100110

100102

200367

200091

100079

100079

200111

200090

200089

200127

100140

100136

200123

100124

100427

200092

200368

200370

200372

200088

200044

200055

200125

100051

200048

Chain(Specify Length)	285048
Offset Link	285049
Connecting Link	285050

48"	100533
60"	100534
72"	100535
84"	100536

48"	100537
60"	100538
72"	100539
84"	100540

Std. Feed	100441
Skew Feed	102103

100148

100149

100435

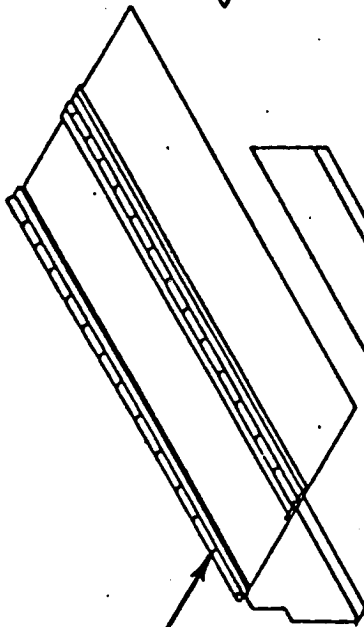

100440

100454 2 Req'd.

100434

48	100436
60	100437
72	100438
84	100439

10039

100128

100127

101112 4 Req'd.

100890

Complete Frame	
48"	100035
60"	100036
72"	100037
84"	100038

48"	100446
60"	100447
72"	100448
84"	100449

48"	100432
60"	100433
72"	100430
84"	100431

100430 2 Req'd.

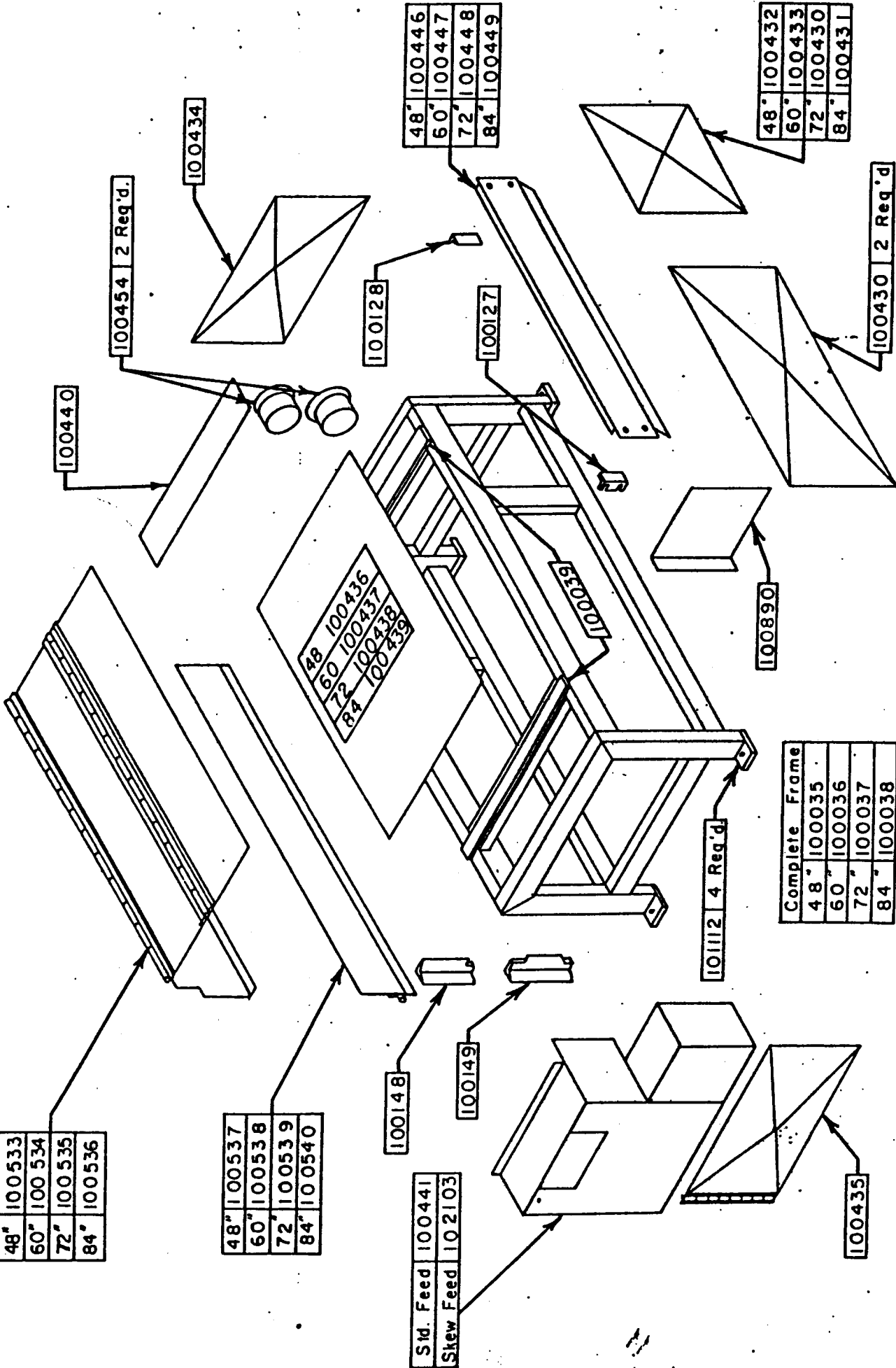

3590 / 4000 FRAME AND PANELS



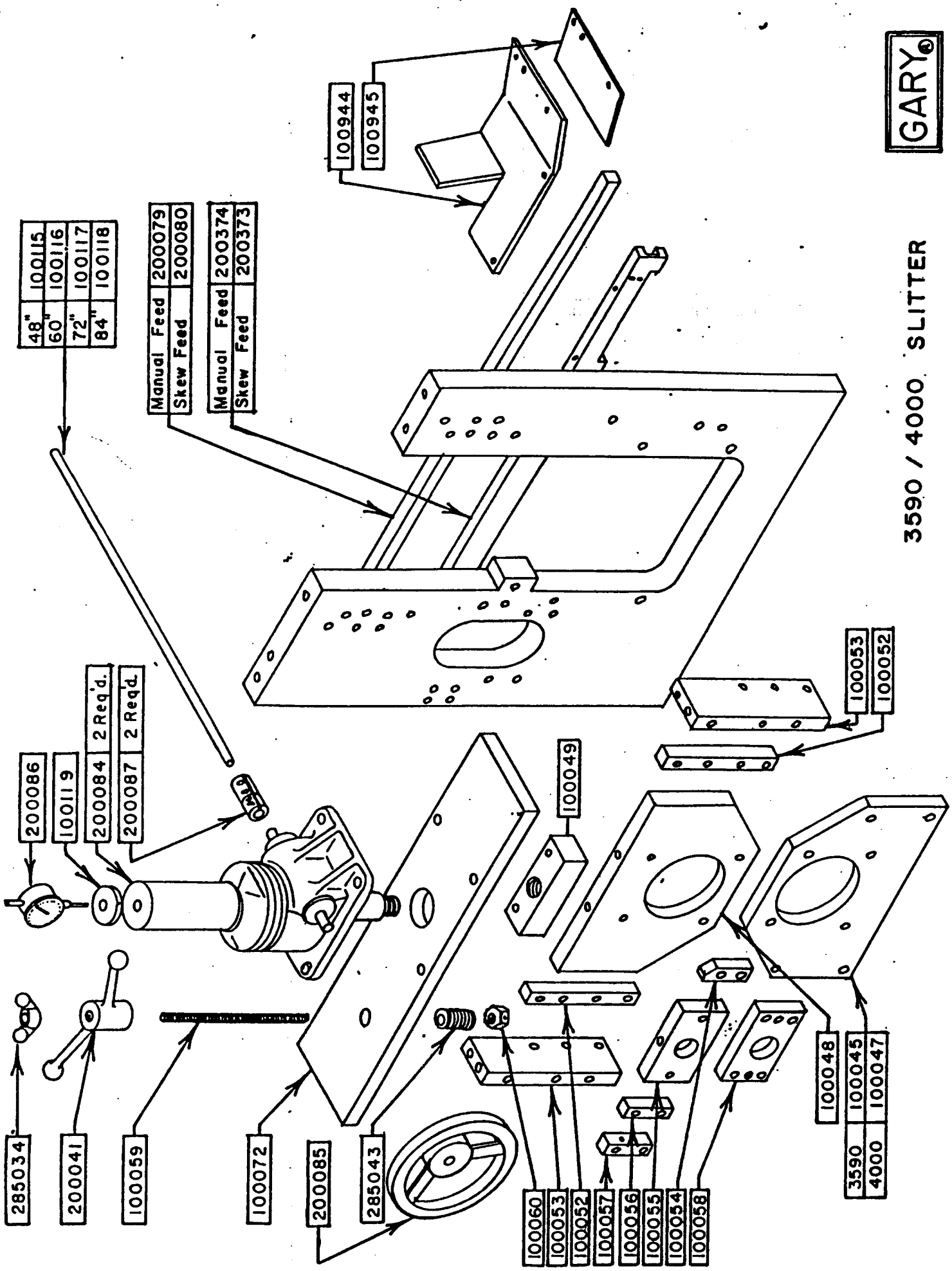

GARY®

3590 / 4000 SLITTER



3590 / 4000 MANUAL FEED ENTRY DRIVE

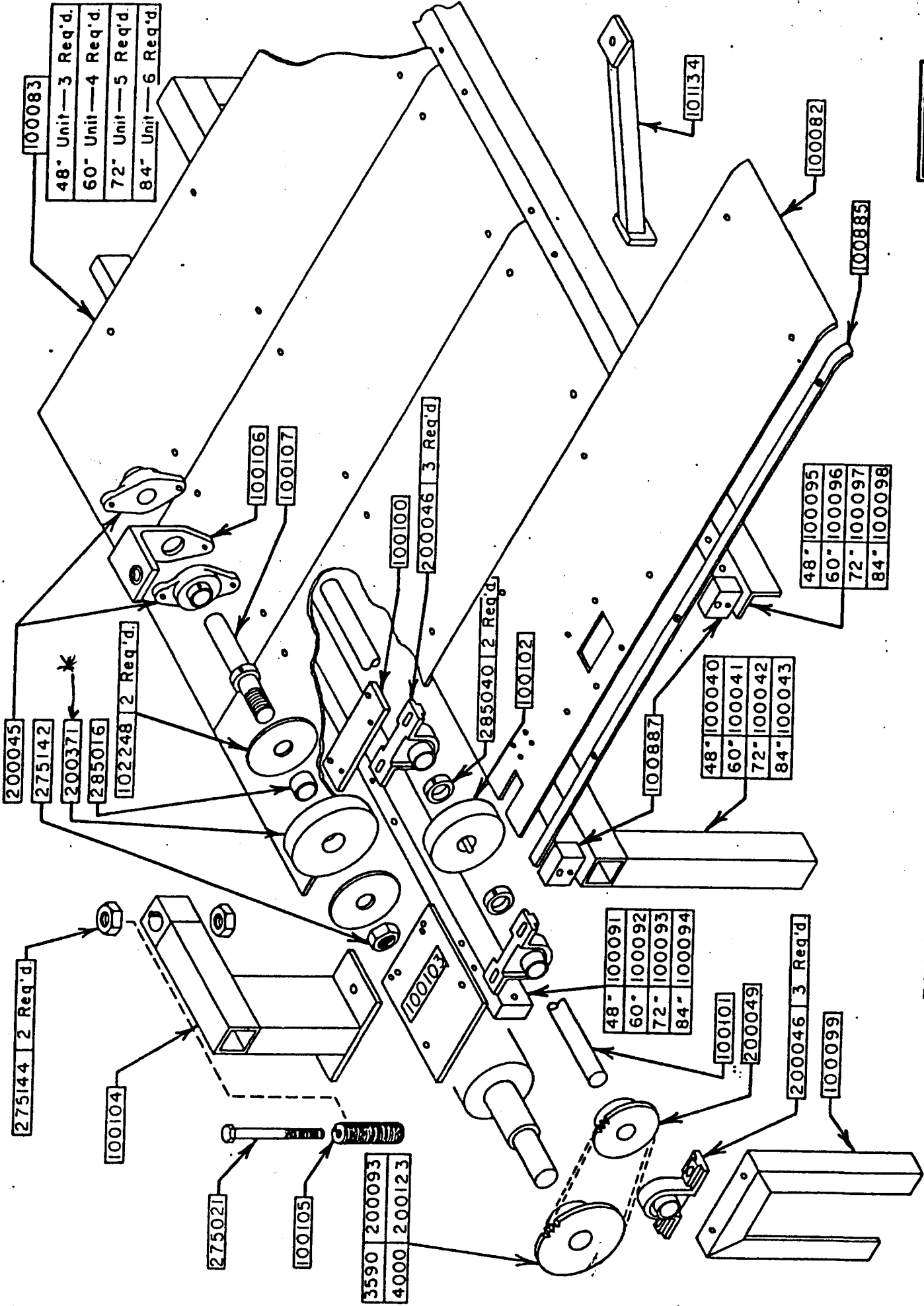

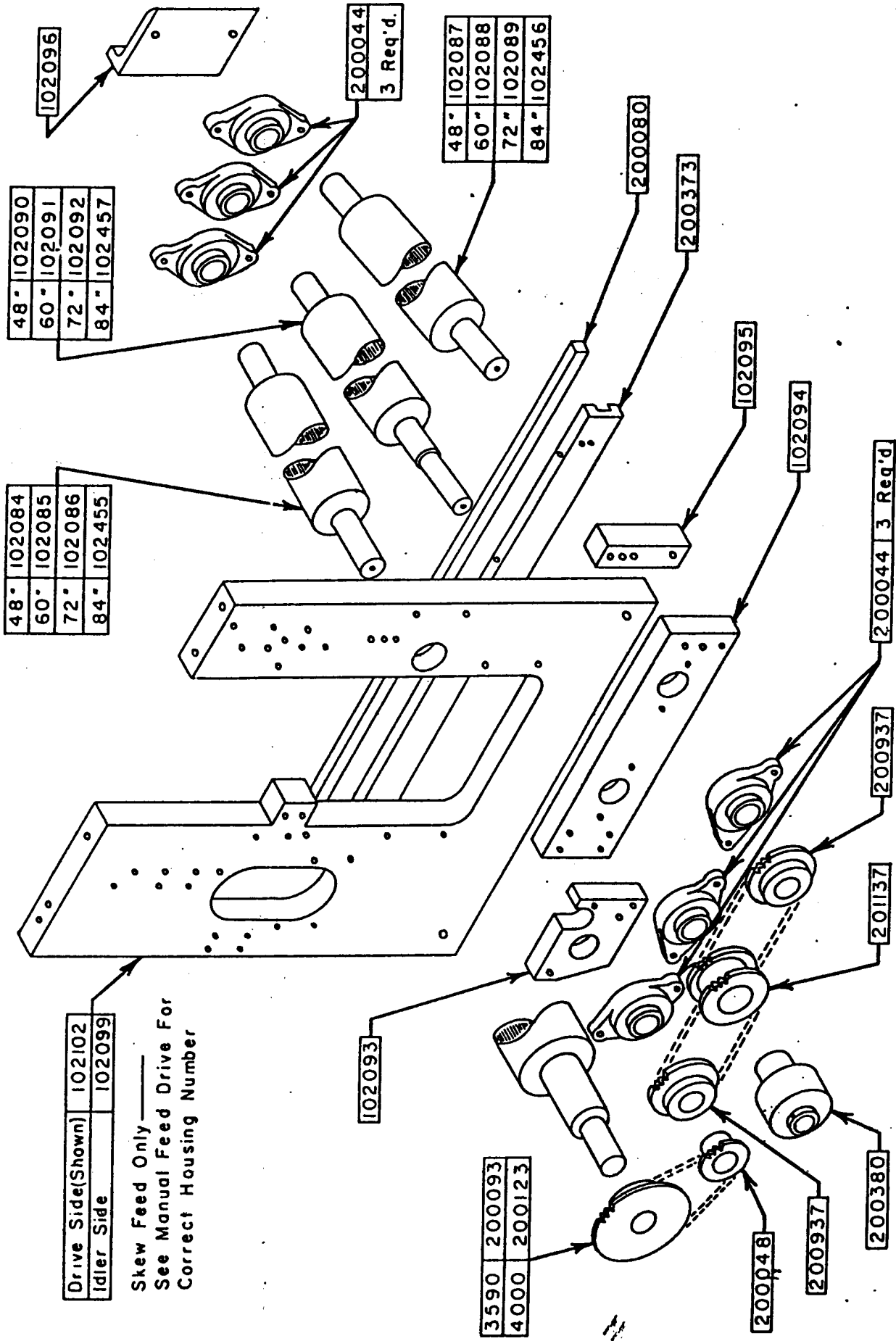

3590 / 4000 SKEW FEED ENTRY DRIVE

2 Position Selector	285163
Repl. Contact Block	285162
Pendant Assembly	100428
Repl. Toggle Switch	285092
Repl. Push Button	285093
Repl. Coil Card	285146

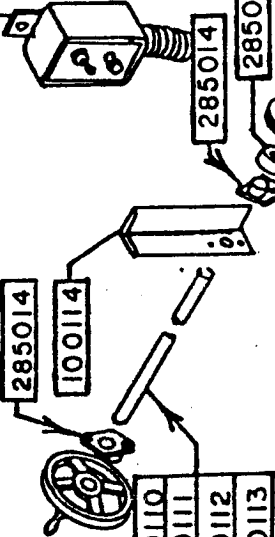

ALL 48"	100110
60"	100111
72"	100112
84"	100113

200047	Chain (Specify Length)
285048	Offset Link
285050	Connecting Link

200050	3590-48"	200122
	3590-60,72"	200103
	4000-All	202460
	3590-48"	200117
	3590-60,72"	200098
	4000-48"	200216
	4000-60,72,84"	202457

3590-48"	200121
3590-60,72"	200102
4000-48"	200062
4000-60,72,84"	200121

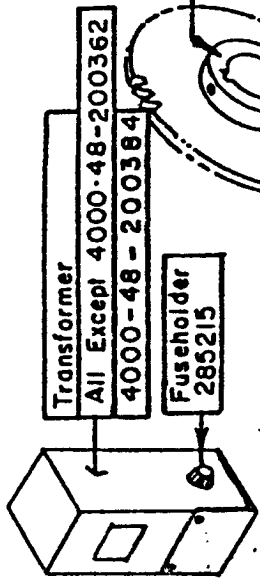

Transformer	All Except 4000-48-200362
	4000-48-200384
Fuseholder	285215

3590-48"	200120
3590-60,72"	200101
4000-48"	200218
4000-60,72,84"	200120

100778	3590-60,72"	200099
	3590-48"	200118
	4000-All	200118

All Except 4000-48"	3590-All	200054
	4000-48"	200303
	4000-60,72,84"	200054
	Chain (Specify Length)	
	Offset Link	
	Connecting	
	4000-48	
	Chain (Specify Length)	
	Offset Link	
	Connecting Link	



4000-48"	Sprocket	200361
60,72,84"		200359
3590 All		200359
Bearing-All Units		200360
Tensioner Base-All		200358
Tensioner Shaft		200666
Bronze Thrust Washer		200723
Set Collar		285041

3590-48"	200094
3590-60,72"	200095
4000-48"	200058
4000-60,72,84"	200124
3590-48"	200119
3590-60,72"	200100
4000-48"	200217
4000-60,72,84"	200119

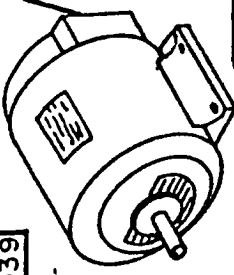

100778	3590-60,72"	200099
	3590-48"	200118
	4000-All	200118

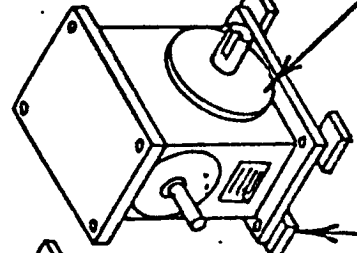

Mount Pad	3590-60,72"	185001
	3590-48"	185004
	4000-All	185004

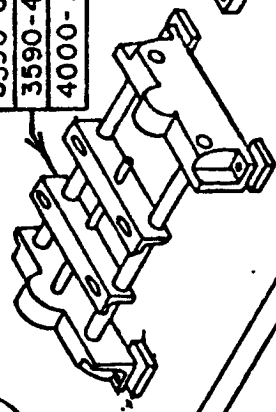

3590-60,72"	285001
3590-48"	285006
4000-All	202457

3590-48"	200116
3590-60,72"	200097
4000-All	202458



**MODEL 3590 / 4000 SLITTER
MAIN DRIVE**

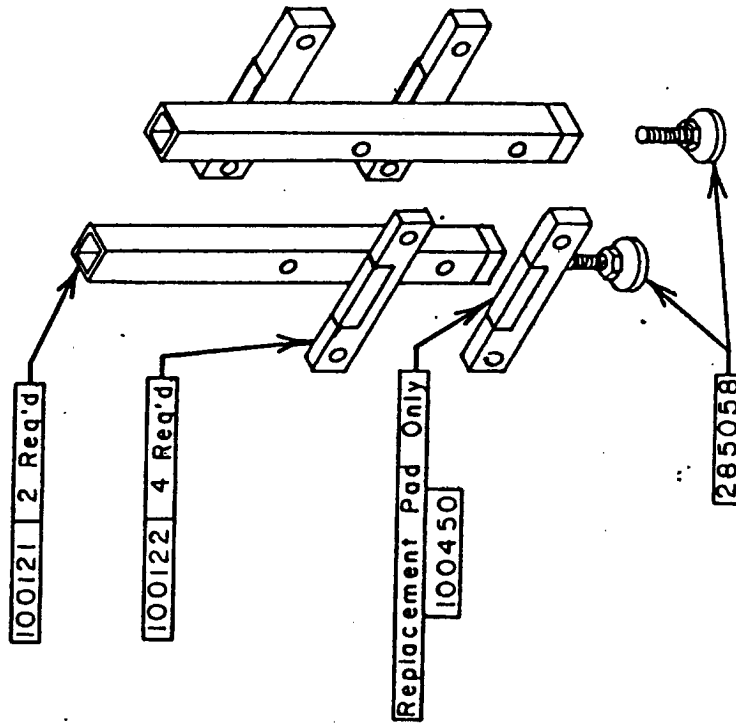
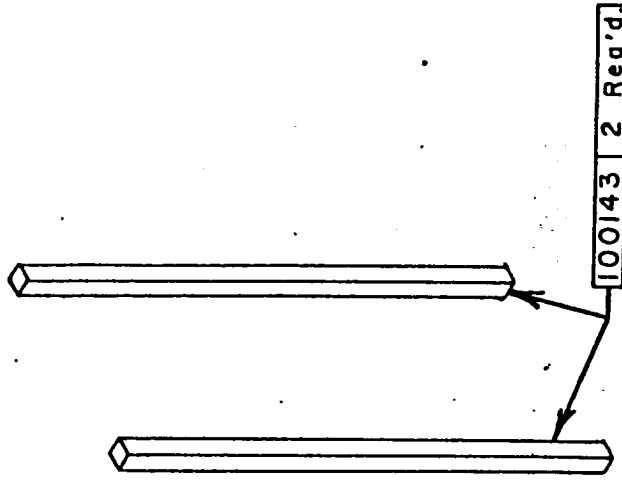
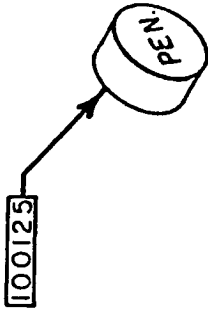
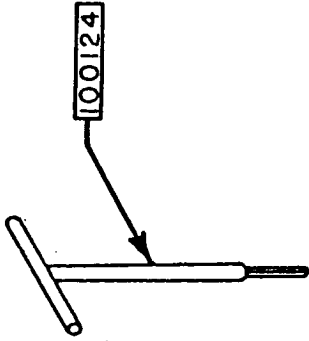

AEROSOL GEAR GREASE (Not Shown) 285204



3590 / 4000 MAINTENANCE ACCESSORIES